

# AP Memory Technology Corp.

## 2020 First Half Investor Conference

Aug. 10, 2020

# DISCLAIMER

The forward-looking statements contained in the presentation are subject to risks and uncertainties and actual results may differ materially from those expressed or implied in these forward-looking statements.

AP Memory makes no representation or warranty as to the accuracy or completeness of these forward-looking statements and nor does AP Memory undertake any obligation to update any forward-looking statements, whether as a result of new information or future events.



# OUTLINES

- 1H20 Financial Results
- Business Outlook

# 1H20 Financial Results

# 1H20 Consolidated I/S

(in NT\$K)	1H20	1H19	YoY
Net Revenue	2,035,224	1,476,798	38%
Cost of Revenue	1,587,288	1,264,381	26%
Gross Profit	447,936	212,417	111%
Gross Profit Margin (%)	22%	14%	
Operating Expenses	338,851	331,821	2%
Operating Expense Ratio	17%	22%	
Income from Operations	109,085	(119,404)	
Operating margin(%)	5%	-8%	
Non-operating Income and Expenses	1,895	(330,628)	
Income Before Income Tax	110,980	(450,032)	
Income Tax Expenses(Benefits)	(71)	(13,391)	
Net Income	111,051	(436,641)	
Net Profit Margin(%)	5%	-30%	
Earnings per share(NT\$)	1.51	(5.88)	

# 2Q20 Consolidated I/S

(in NT\$K)	2Q20	1Q20	QoQ	2Q19	YoY
Net Revenue	1,099,070	936,154	17%	809,180	36%
Cost of Revenue	835,031	752,257	11%	642,512	30%
Gross Profit	264,039	183,897	44%	166,668	58%
Gross Profit Margin (%)	24%	20%		21%	
Operating Expenses	185,017	153,834	20%	161,370	15%
Operating Expense Ratio	17%	16%		20%	
Income from Operations	79,022	30,063	163%	5,298	1392%
Operating margin(%)	7%	3%		1%	
Non-operating Income and Expenses	(10,498)	12,393	-185%	8,613	-222%
Income Before Income Tax	68,524	42,456	61%	13,911	393%
Income Tax Expenses(Benefits)	(6,528)	6,457	-201%	(14,258)	-54%
Net Income	75,052	35,999	108%	28,169	166%
Net Profit Margin(%)	7%	4%		3%	
Earnings per share(NT\$)	1.02	0.49	108%	0.38	168%

# Revenue by Product Lines

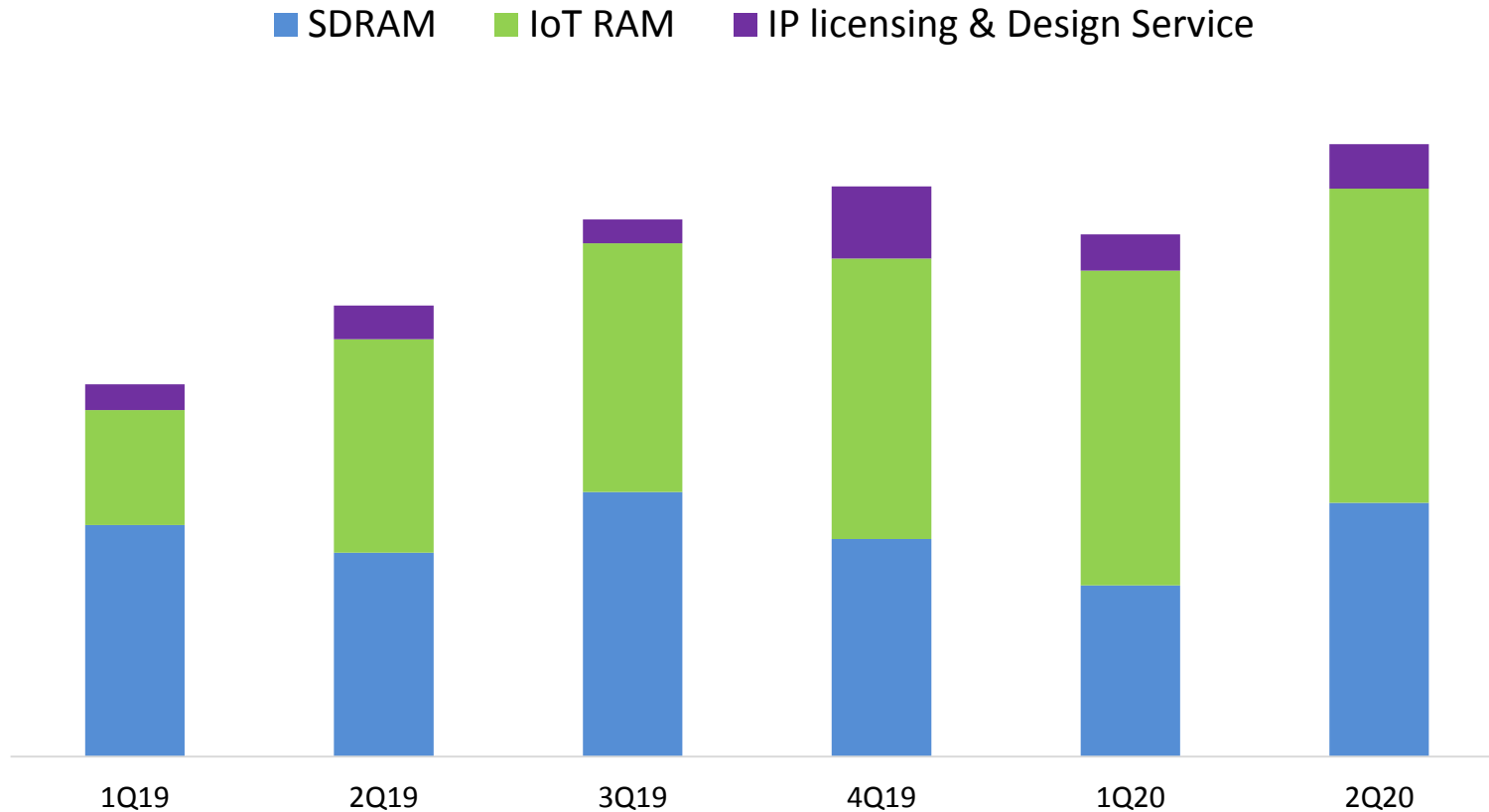

# IoT RAM Revenue by Application

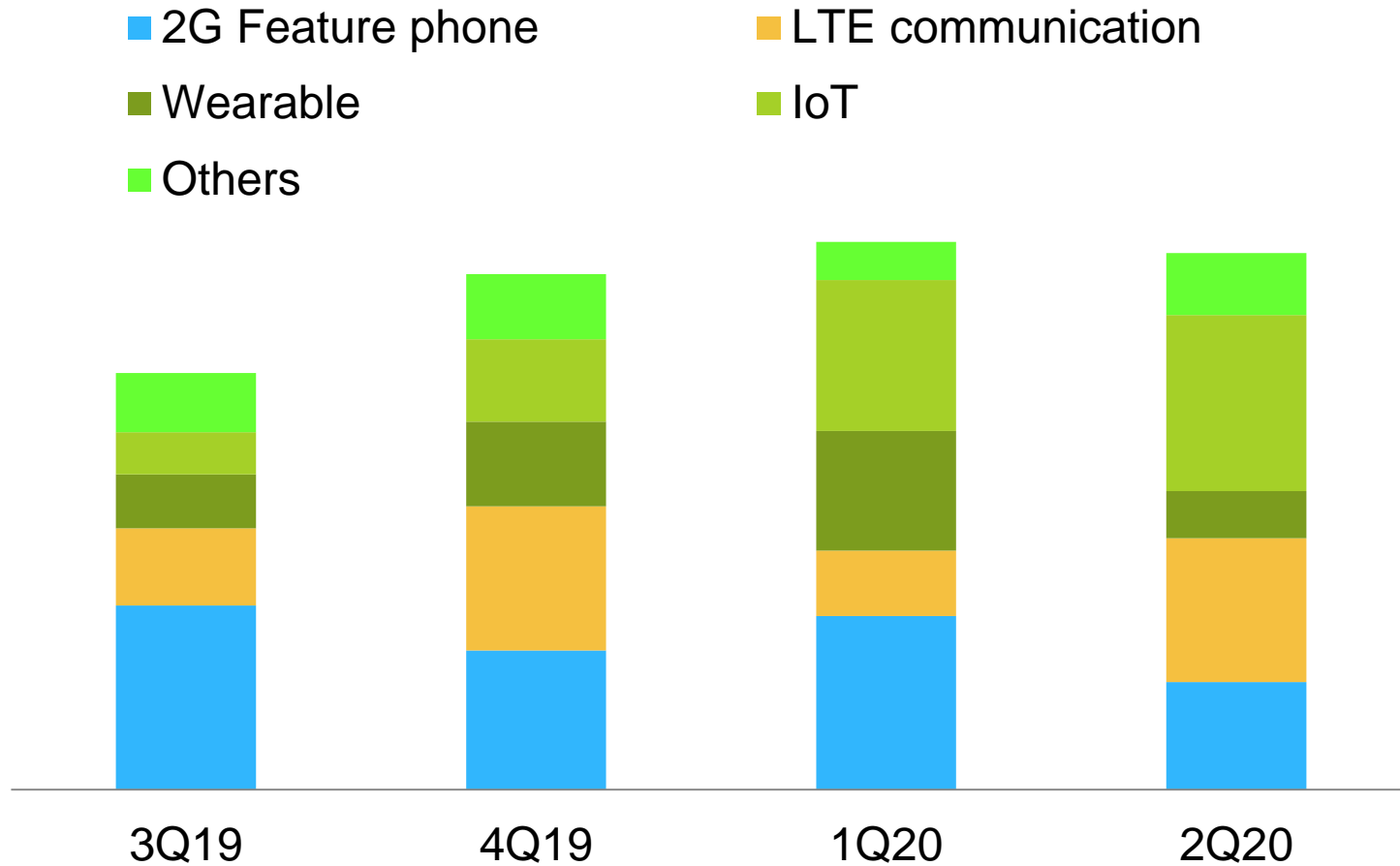



# 1H20 Consolidated B/S

in NT\$K	2020.06.30		2019.12.31		2019.06.30	
	AMT	%	AMT	%	AMT	%
Cash and Cash Equivalents	880,124	26	584,264	18	551,765	17
Accounts/Notes Receivable	702,696	21	588,346	19	345,924	11
Inventories	954,165	28	1,130,802	36	1,467,350	45
Other Current Assets	108,145	3	124,703	4	159,901	5
Long-term Investments	77,961	2	82,525	3	80,263	2
Goodwill and Other Intangible Assets	170,749	5	206,939	6	193,291	6
Refundable Deposits	204,836	6	206,686	7	206,930	6
Other Non-Current Assets	276,061	8	237,906	7	242,901	7
<b>Total Assets</b>	<b>3,374,737</b>	<b>100</b>	<b>3,177,025</b>	<b>100</b>	<b>3,248,325</b>	<b>100</b>
Long/Short-Terms Loans	196,585	6	300,000	9	333,000	10
Accounts Payable	382,297	11	307,382	10	333,546	10
Other Payables-Current/Non-Current	355,048	11	337,524	11	391,442	12
Other Liabilities	47,676	1	69,562	2	62,522	2
<b>Total Liabilities</b>	<b>981,606</b>	<b>29</b>	<b>1,014,468</b>	<b>32</b>	<b>1,120,510</b>	<b>34</b>
<b>Total Shareholders' Equity</b>	<b>2,393,131</b>	<b>71</b>	<b>2,162,557</b>	<b>68</b>	<b>2,127,815</b>	<b>66</b>
Net Worth Per Share	31.9		29.3		28.2	

# Inventory Status

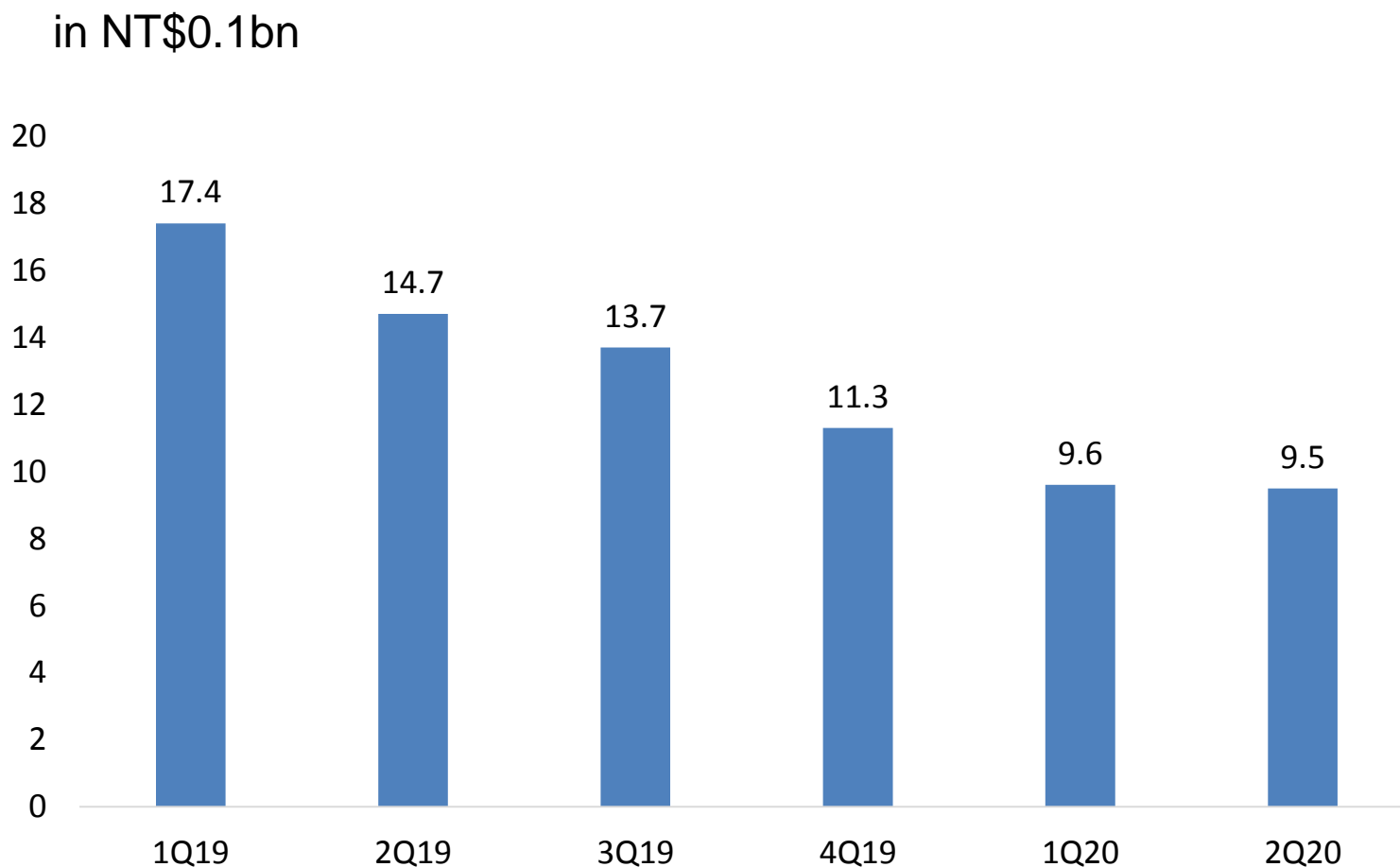

# 1H20 Cash Flows

(in NT\$K)	1H20	2H19	1H19
Net Cash Generated by (Used in) Operating Activities	263,262	203,006	179,669
Net Cash Generated by (Used in) Investing Activities	(6,925)	(78,019)	(9,699)
Net Cash Generated by (Used in) Financing Activities	40,567	(87,126)	(172,742)
Effect of Exchange Rate Changes on Cash and Cash Equivalents and Others	(1,044)	(5,362)	2,492
Net Increase (Decrease) in Cash and Cash Equivalents	295,860	32,499	(280)
Cash and Cash Equivalents at Beginning of Period	584,264	551,765	552,045
Cash and Cash Equivalents at End of Period	880,124	584,264	551,765

# 2Q20 Financial Ratios

	2Q20	1Q20	4Q19
Current Ratio	318%	349%	301%
Quick Ratio	202%	214%	157%
Average A/R collection days	57	61	72
Days sales of inventory	122	151	220
Net income %	7%	4%	-11%
ROA	10%	5%	-11%
ROE	13%	6%	-16%

# Business Outlook

# Operating Results Improving

NT\$M

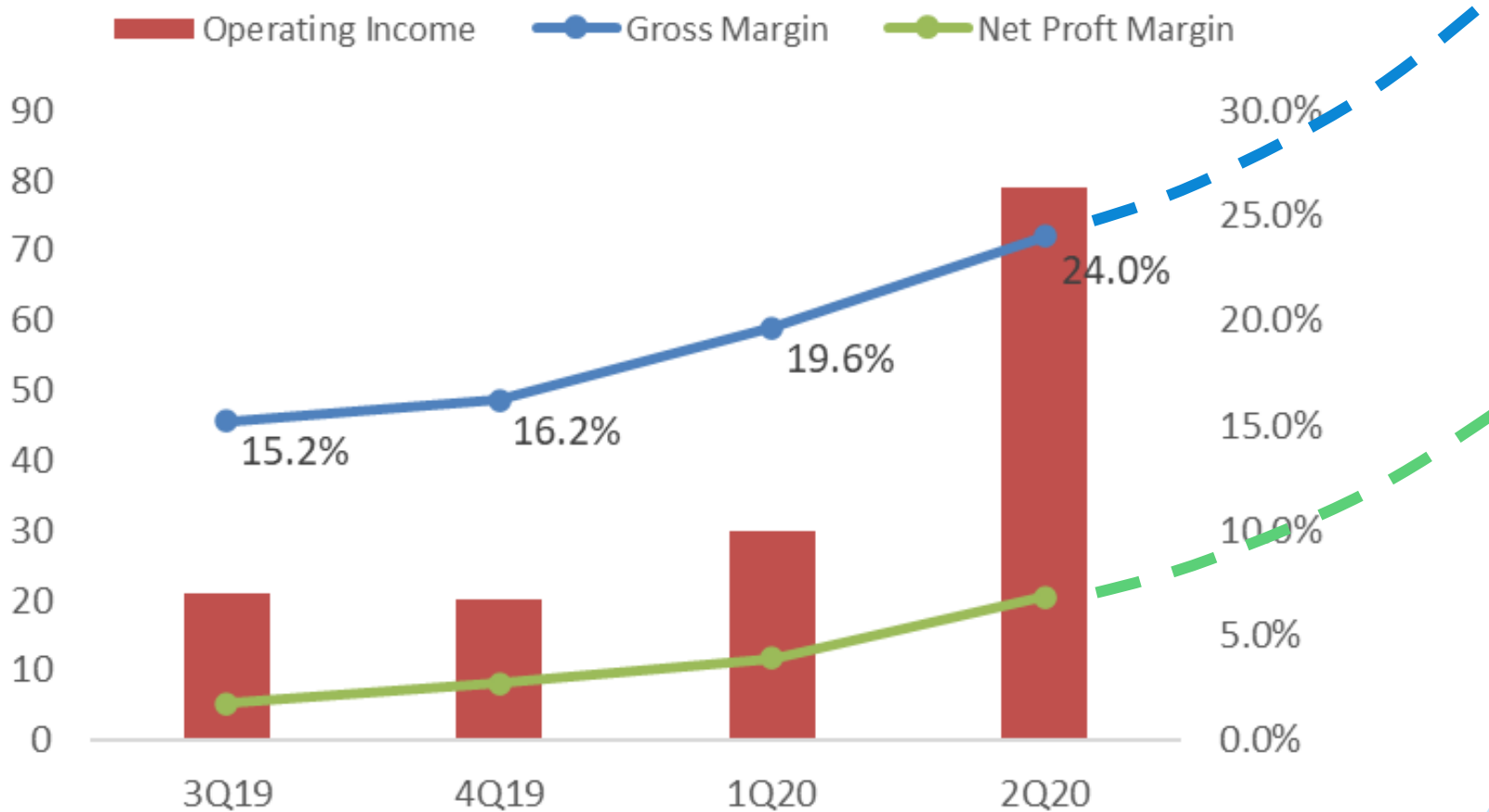

# IoT RAM Market Opportunity

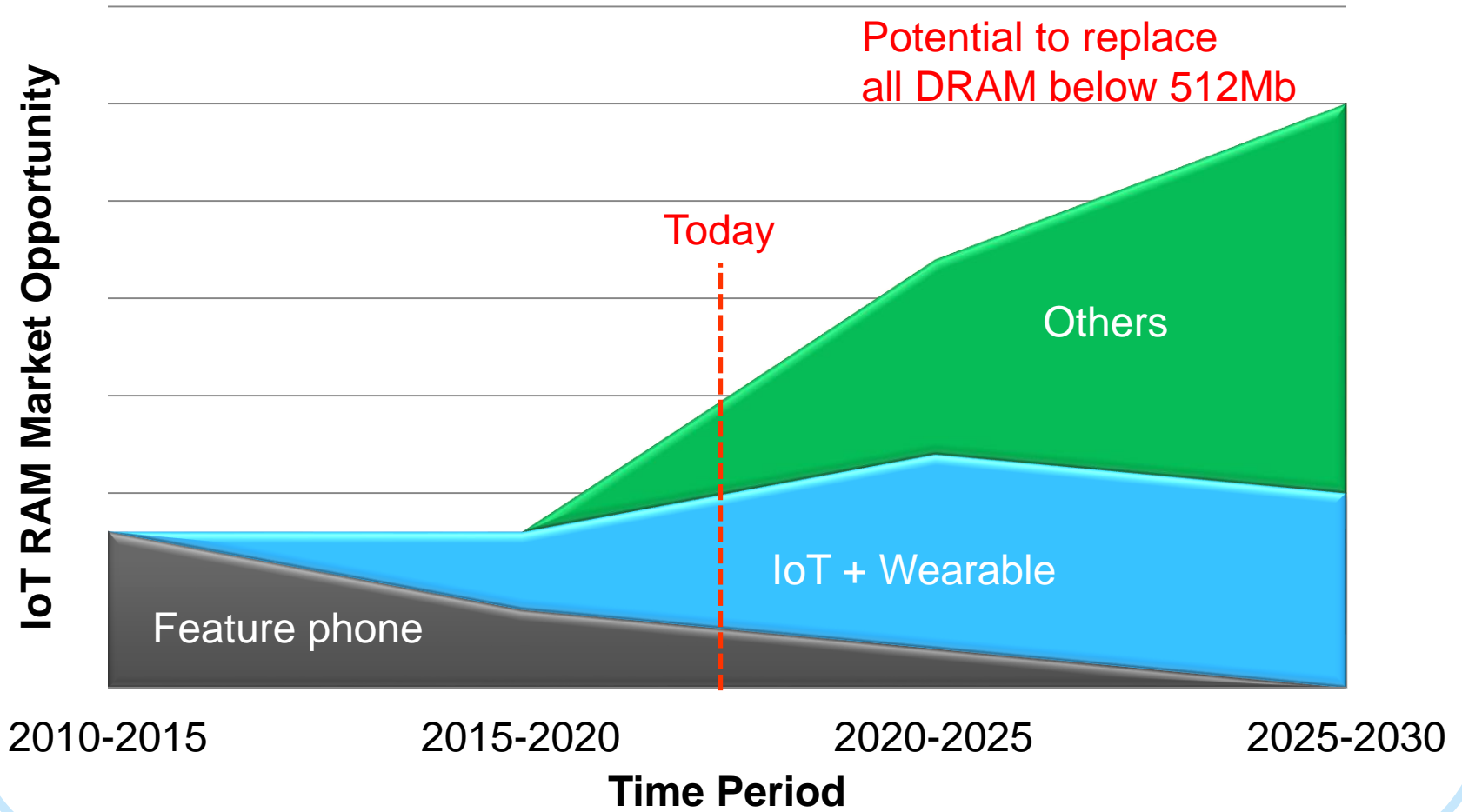

# AI Memory

[from 9/13/2018 Investor Meeting]

## 2.5D

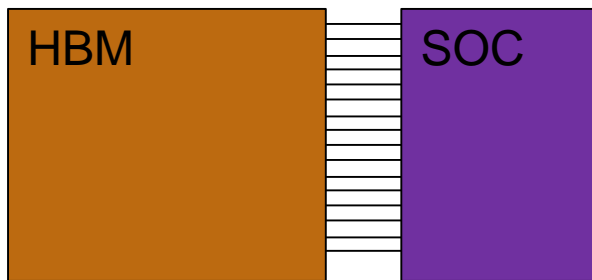
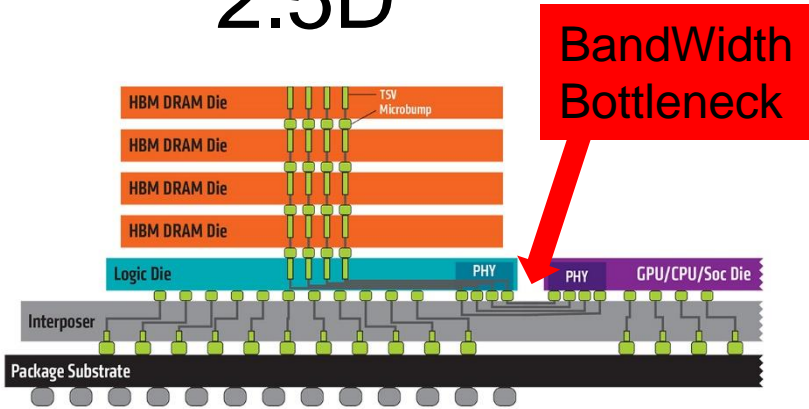

~2,000 connections

## 3D

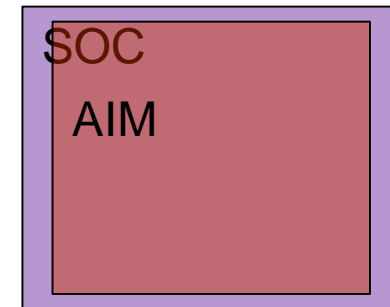
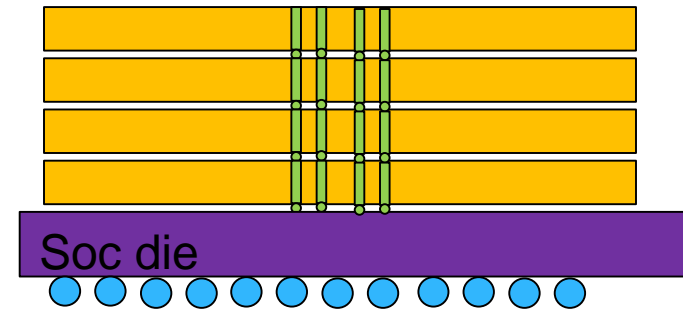

Millions of connections



# 3D AI Memory Potential Applications

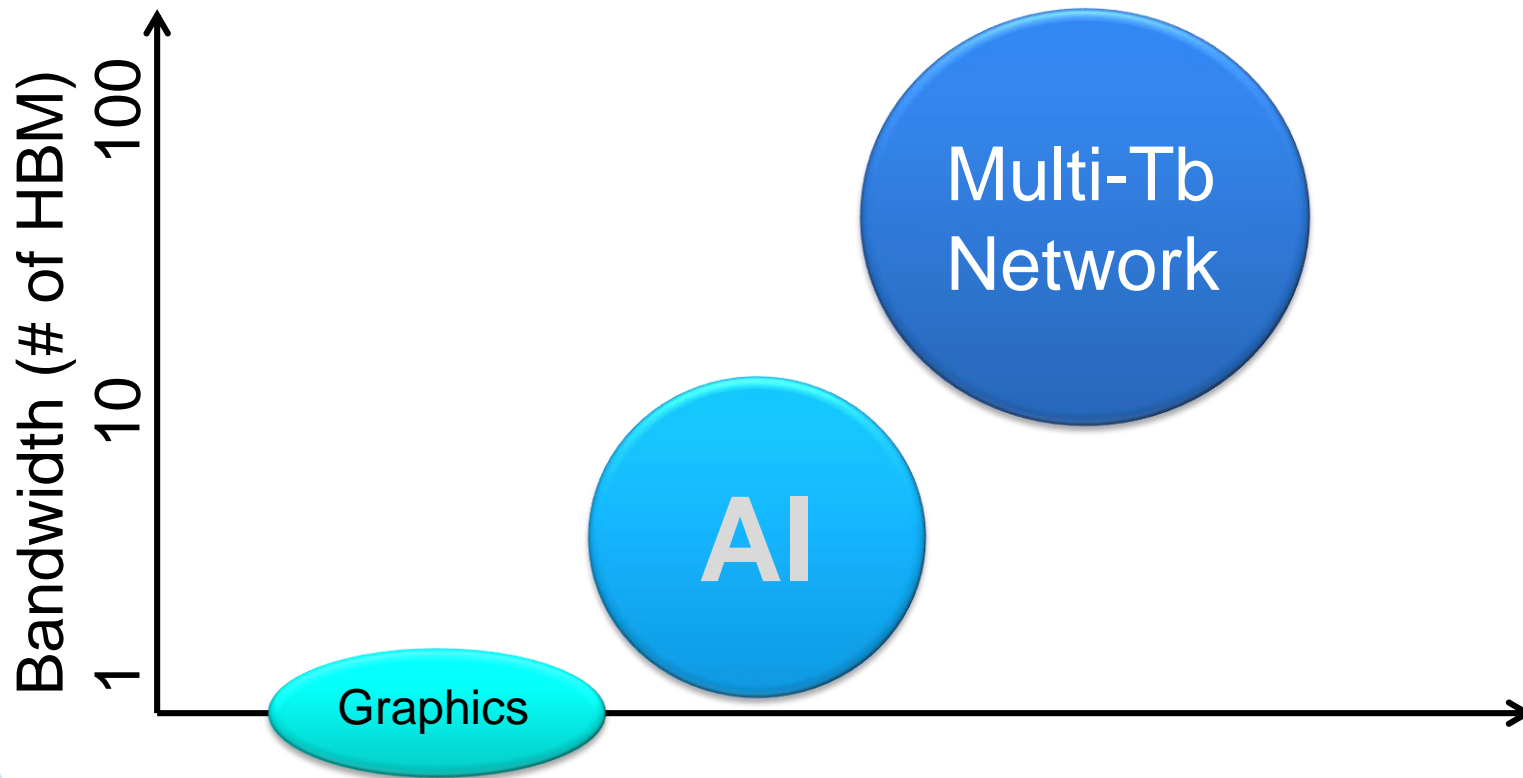

# Long-term Revenue Trend

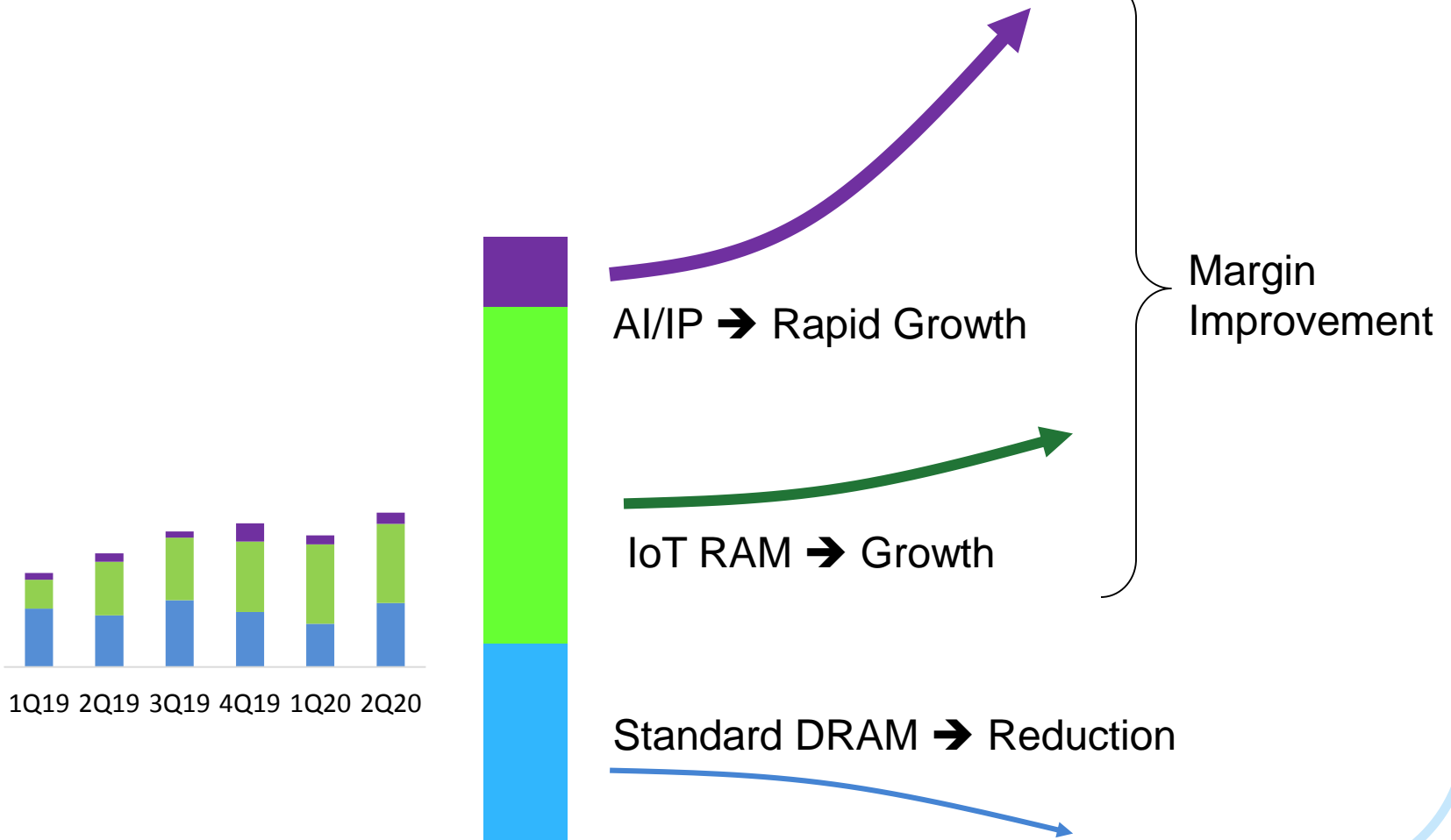



## Q & A

發言人信箱：[ir@apmemory.com](mailto:ir@apmemory.com)

發言人專線：(03)5601651